



DAR AL ARKAN



TOWER
DA VINCI
Interiors by
PAGANI

PAGANI

DAR AL ARKAN

“Art and science are disciplines
that can walk hand in hand”

Leonardo Da Vinci

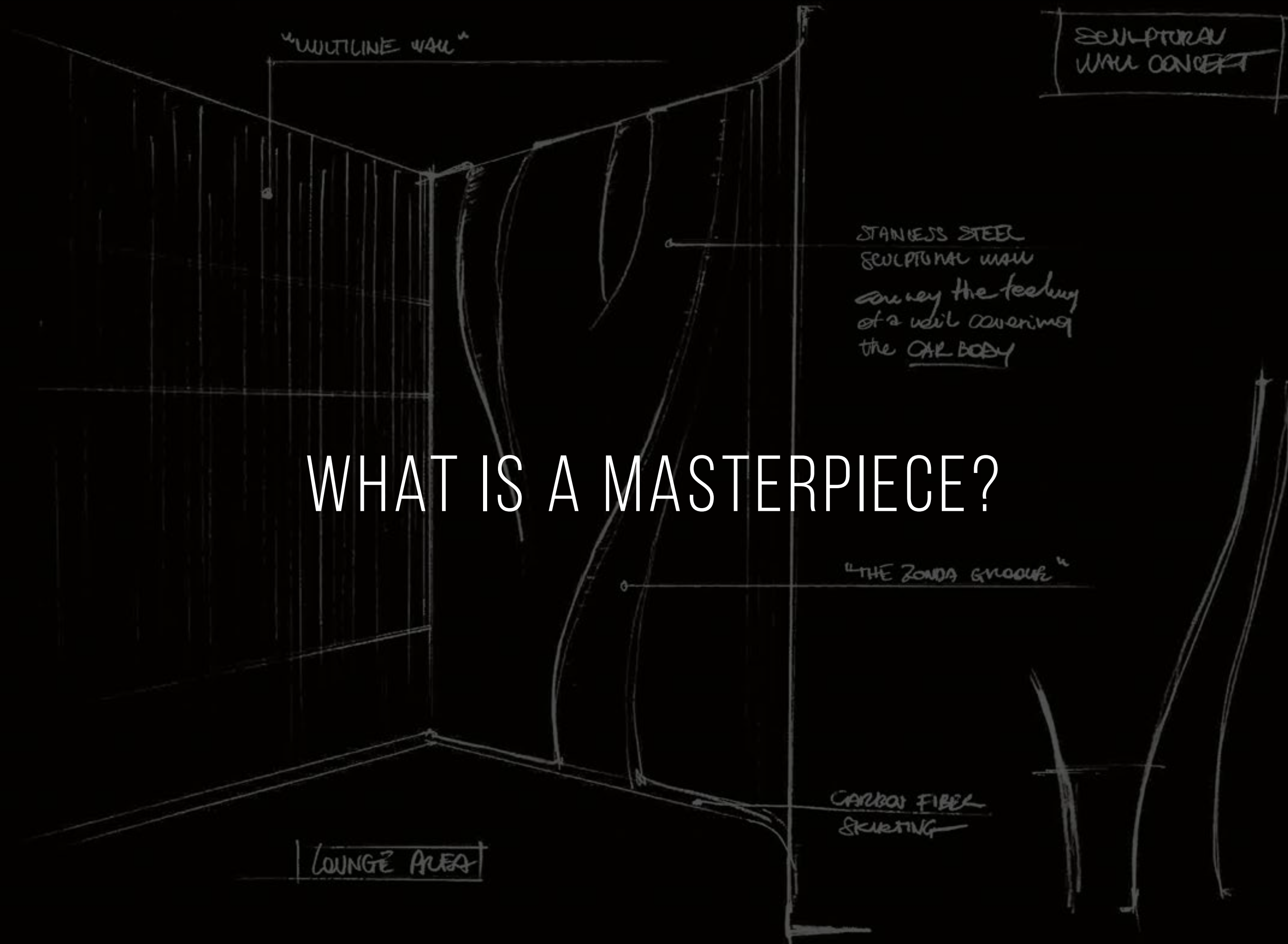

WHAT IS A MASTERPIECE?

IS IT MAGNETIC *beauty* MADE OF SINUOUS LINES?



IS IT ENGINEERING *marvel*
PURSUING UNPRECEDENTED PERFORMANCES?

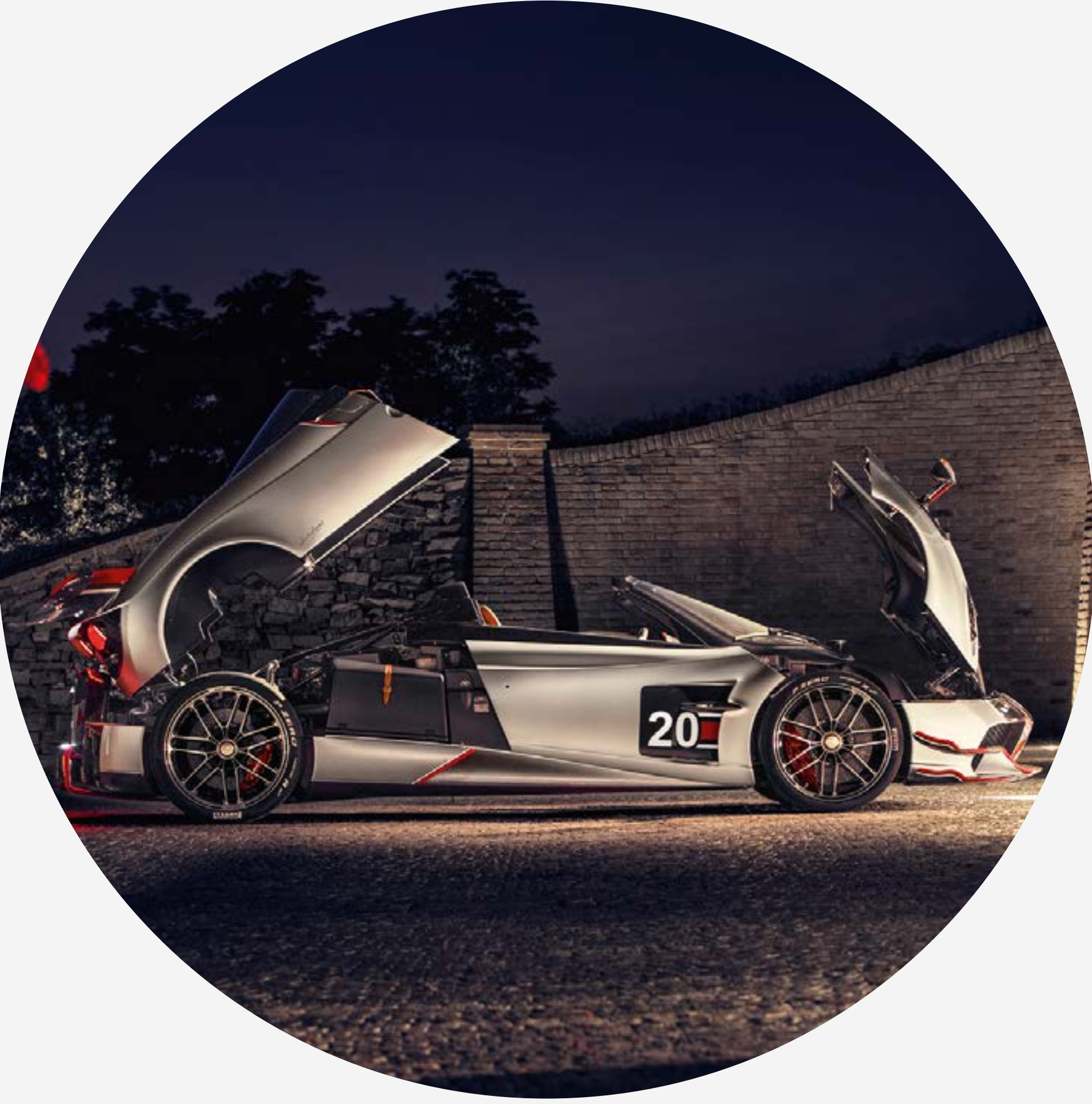
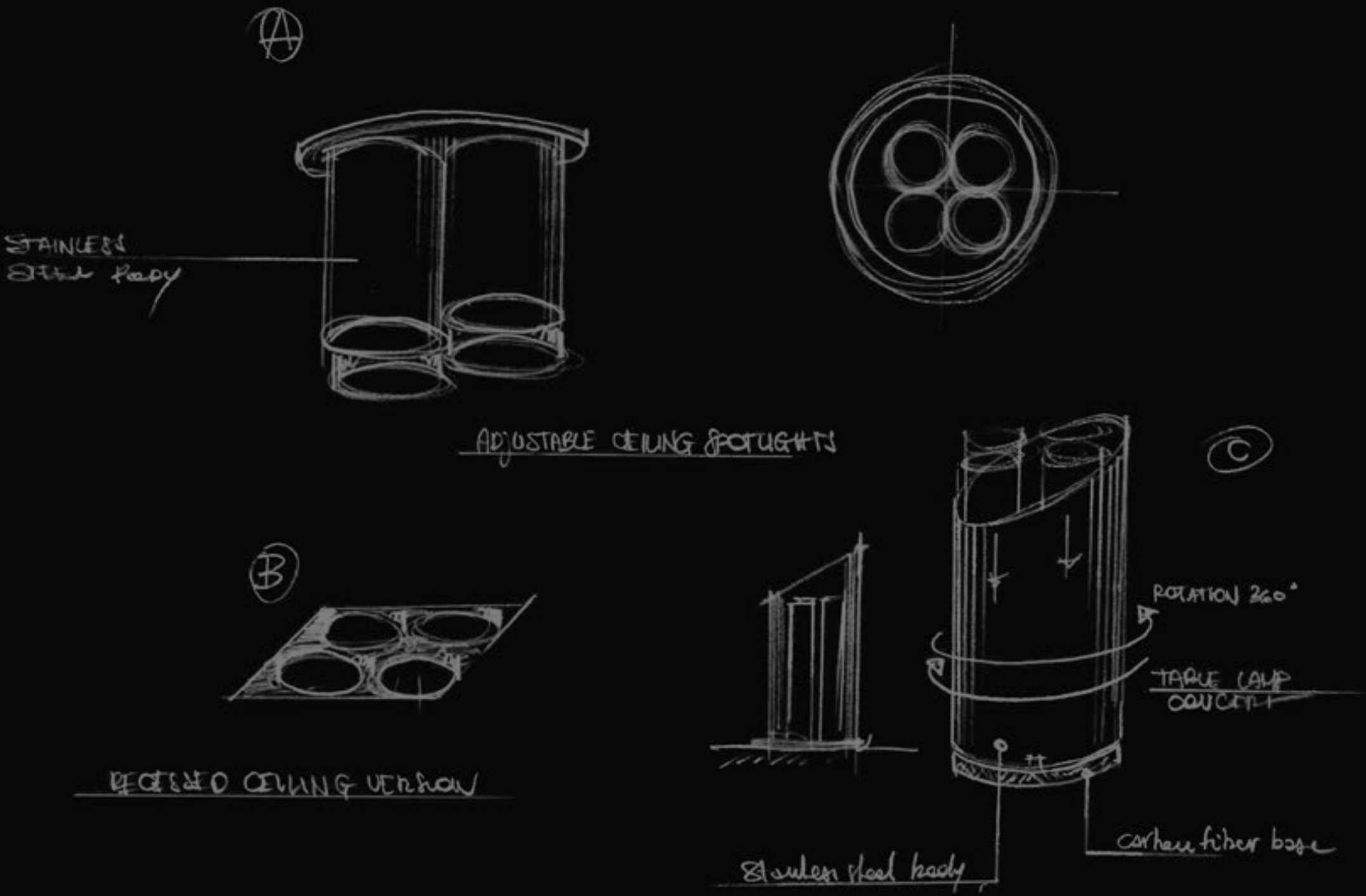

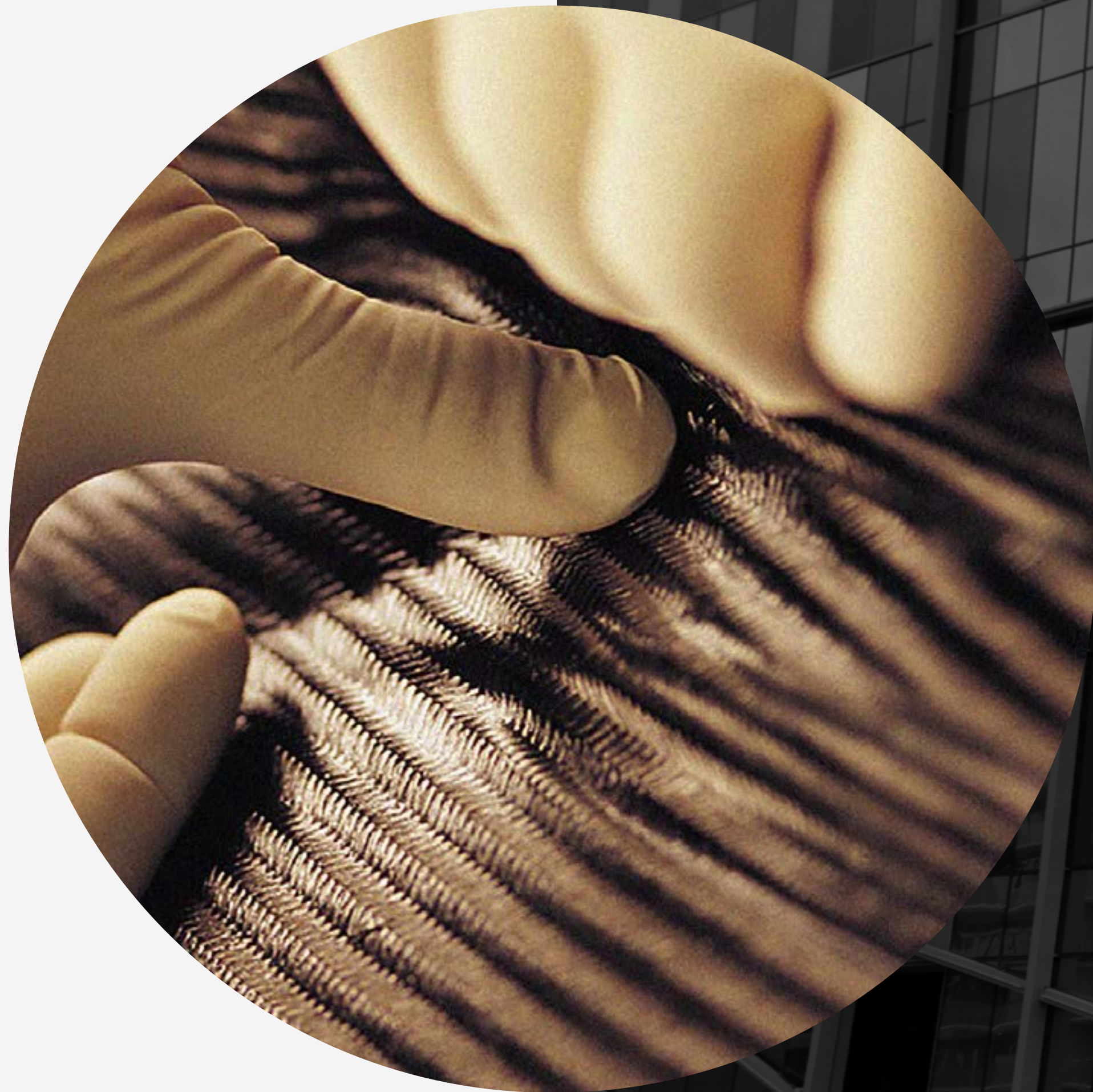

IS IT TAILOR-MADE *details* CRAFTED
TO EXTREME PERFECTION?

IT IS ALL OF IT. AND WAY MORE.



DAR AL ARKAN





CREATURES *of* ART



Horacio Pagani had a dream, and his dream was to create the most beautiful car in the world. Not only he succeeded, but he created a universe that goes beyond the automotive field, a dimension that only few can aspire to. With Leonardo Da Vinci's intuition in mind, Horacio blended beauty and function together, giving life to the unprecedented world of Pagani.

THE SHAPE OF *speed*

Pagani's first residences ever are brought to life in a unique tower. The building design is one that makes your head turn: the instability of lines, a strong uneven approach, transparency and hidden balances create a dynamic effect like no other in the surroundings. But it's when you get closer that you discover the pearl, an incredible suspended sphere that defies gravity. The tower is a true geometric symphony of perfection with 19 floors of residential masterpieces, 3 basement levels and a majestic ground floor.



AT THE CORE OF *contemporaneity*

Dubai is likely becoming the art capital of the 21st century. Home to the most prominent exhibitions, fashion shows, arts and cultural events, DaVinci Tower sits at the heart of it all.

The building is directly by the Dubai Canal, overlooking the world's tallest building Burj Khalifa and a stone throw away from Marasi Business Bay. A prime location filled with a unique mix of aesthetic residential and commercial towers, attracting the most affluent people from around the world.



LOCATION

DIRECTLY ON
THE DUBAI CANAL

A 3.2 Km-long tourist landmark

5 MINUTES
THE DUBAI MALL

The world's largest retail & entertainment destination

4 MINUTES
THE DUBAI FOUNTAIN

The world's tallest performing fountain with a captivating water, music & light spectacle

7 MINUTE
BURJ KHALIFA

The world's tallest building

7 MINUTES
THE DUBAI OPERA

2000 seat multi-format venue

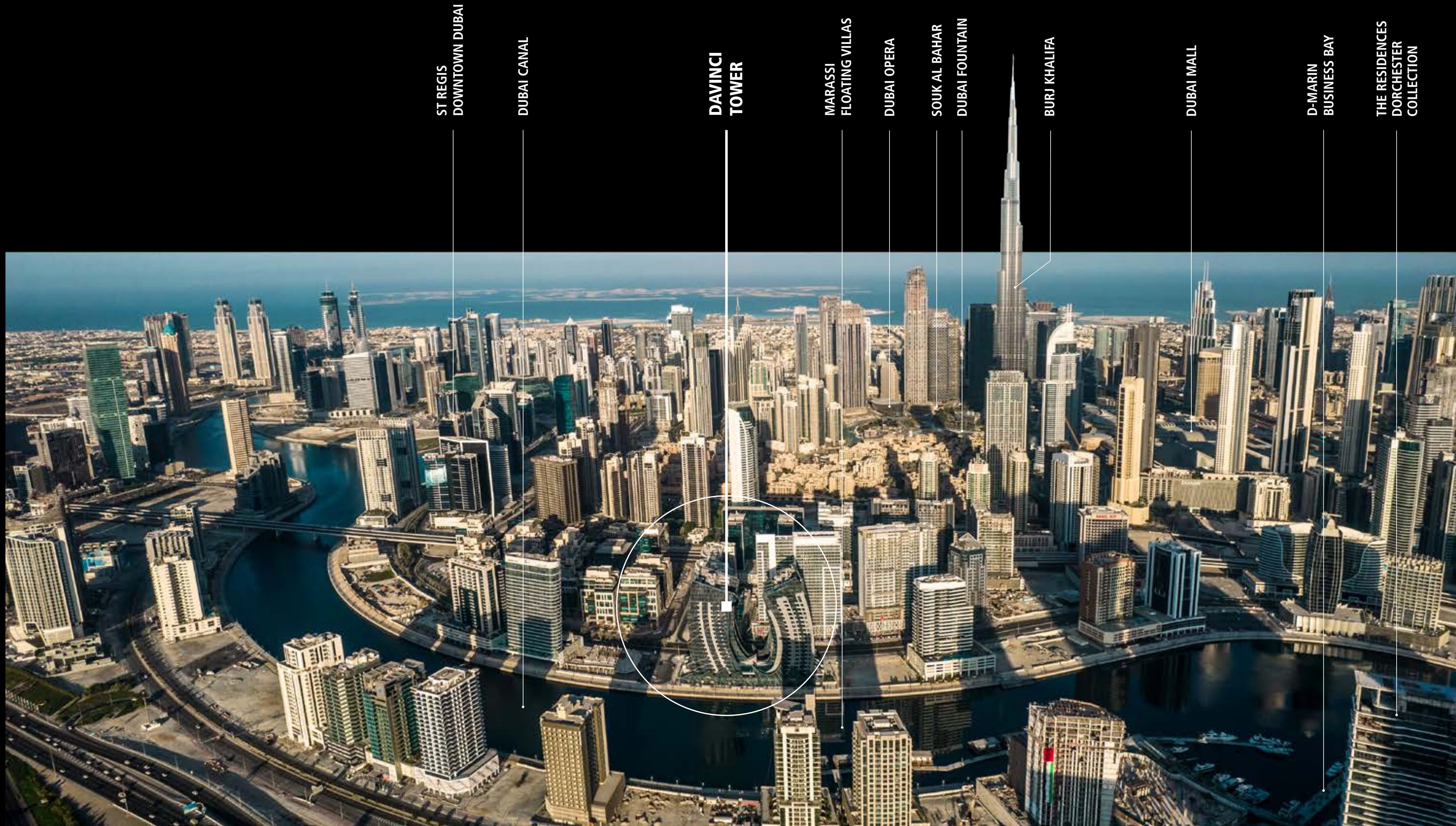

ST REGIS
DOWNTOWN DUBAI

DUBAI CANAL

DAVINCI
TOWER

MARASSI
FLOATING VILLAS

DUBAI OPERA

SOUK AL BAHAR

DUBAI FOUNTAIN

BURJ KHALIFA

DUBAI MALL

D-MARIN
BUSINESS BAY

THE RESIDENCES
DORCHESTER
COLLECTION

BREATHTAKING *views*

The building sits in a strategic position, letting you enjoy the best of Dubai's panoramas. On the South-East side you can indulge in the soothing view of water, with the Canal, the floating villas and the Business Bay at your feet. On the North side, the Burj Khalifa stands just outside of your window.



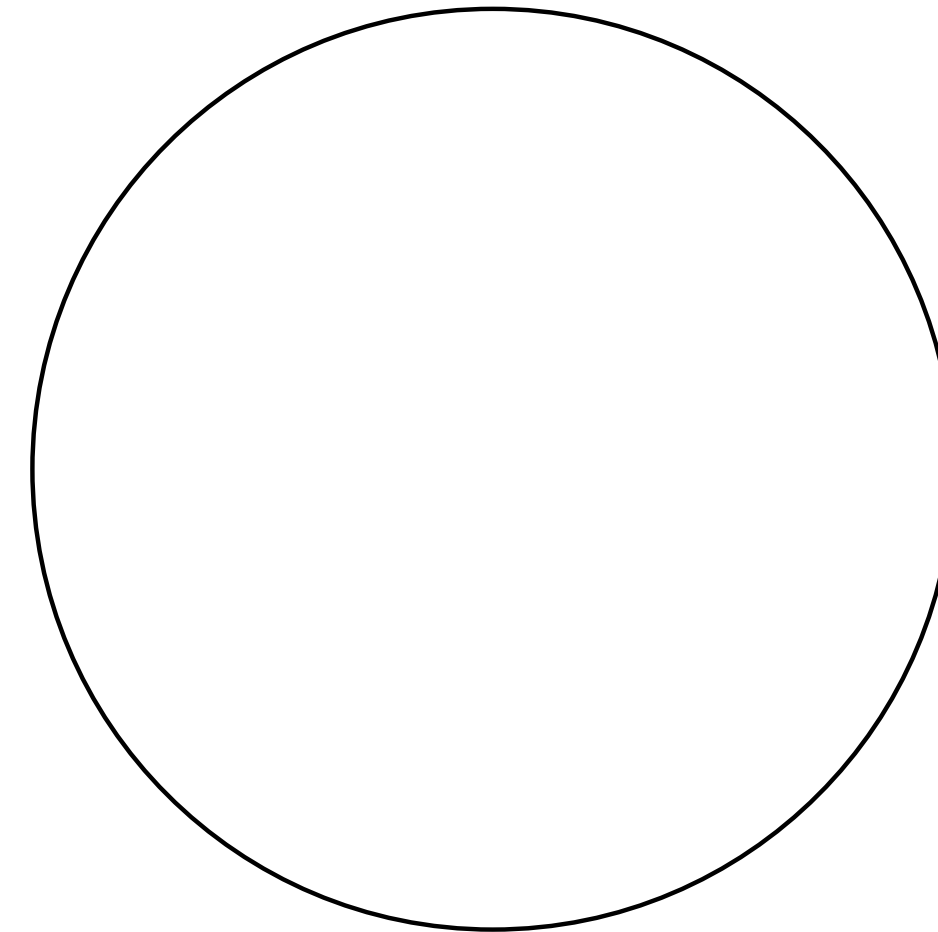
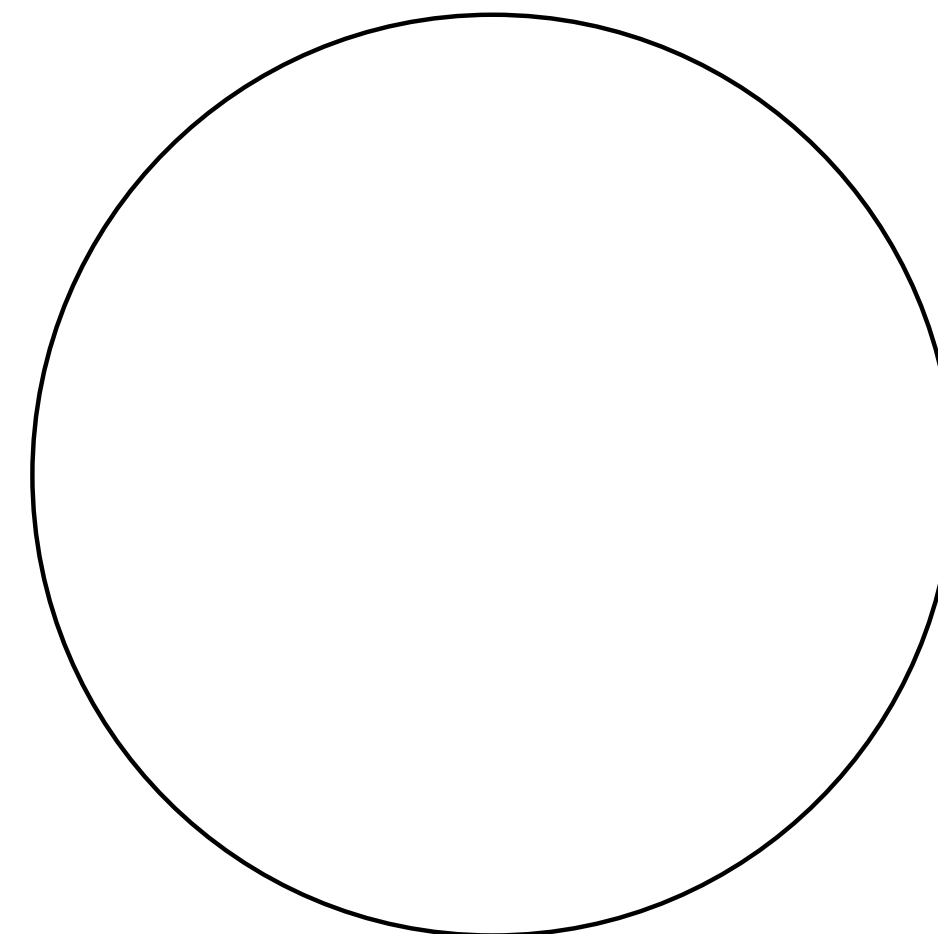

LIVING *above luxury*

For the first time in the world, Pagani's essence takes the shape of a living space: DaVinci Tower is a residential building in downtown Dubai with interiors designed by Pagani. Every detail is crafted to obsession, every material is of the finest quality, every line is designed with taste and harmony, resulting in the unique experience of inhabiting a masterpiece.







ART ELEVATES *Life*

The magnificent residences set new standards for human living. The expansive 2 - 4 bedroom marble homes are designed with private outdoor spaces and open flowing light-filled interiors, with panoramic views of the canal and Downtown Dubai.

Arrive at your doorstep with luxurious elevators dedicated to residents and guests only, then make yourself at home with advanced domotics that responds to any of your desires.





THE STEEL ATRIUM

Beauty IS A SHARP BLADE

Inspired by the sinuous curves of Pagani Design, the Steel Atrium represents the epitome of art and luxury. From the moment you walk in, you are are plunged in a masterpiece made of stainless steel, carbon fibers, lush leather and kinetic chandeliers, where the beauty of engineering evokes the most prestigious lifestyle.



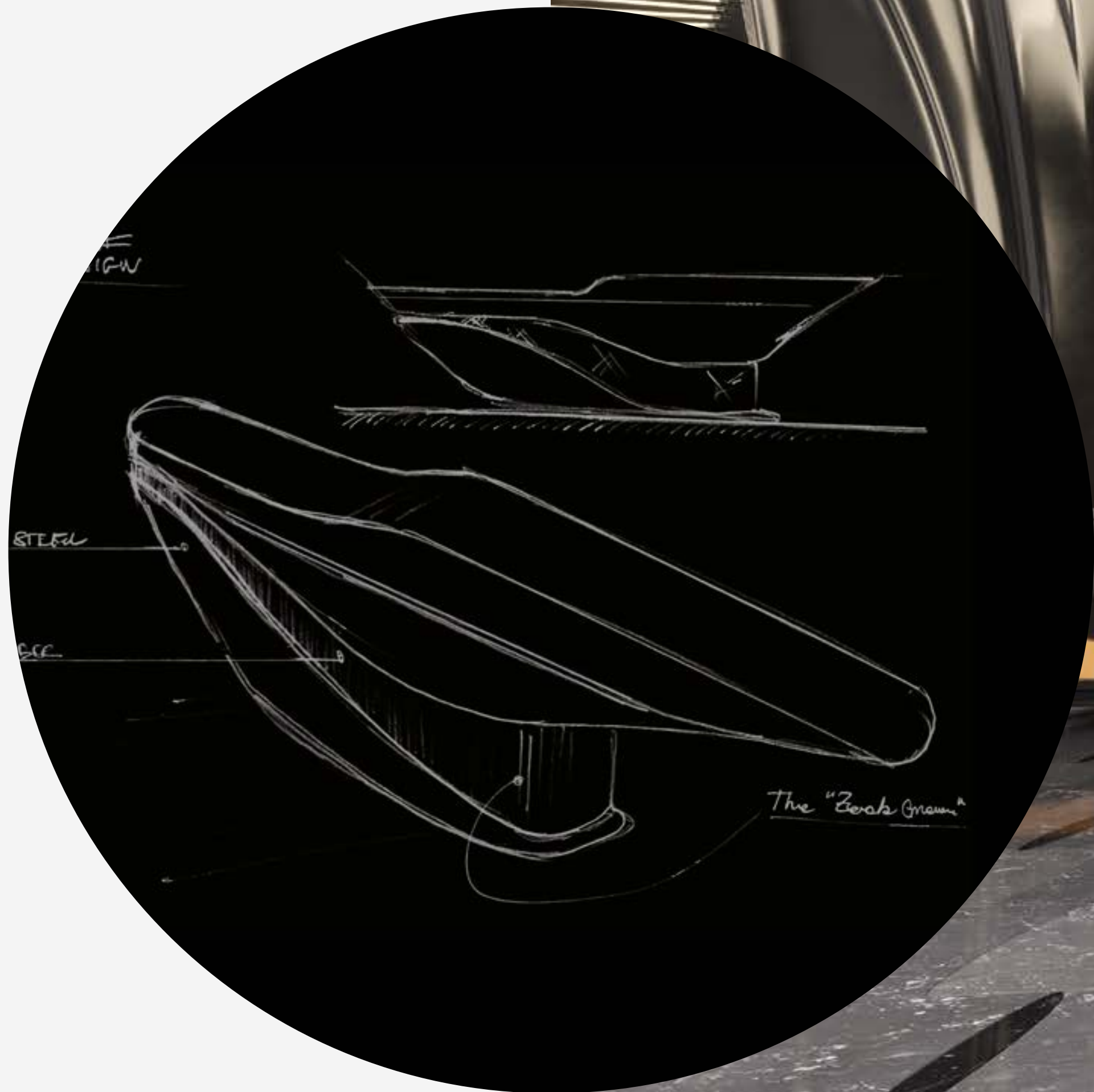
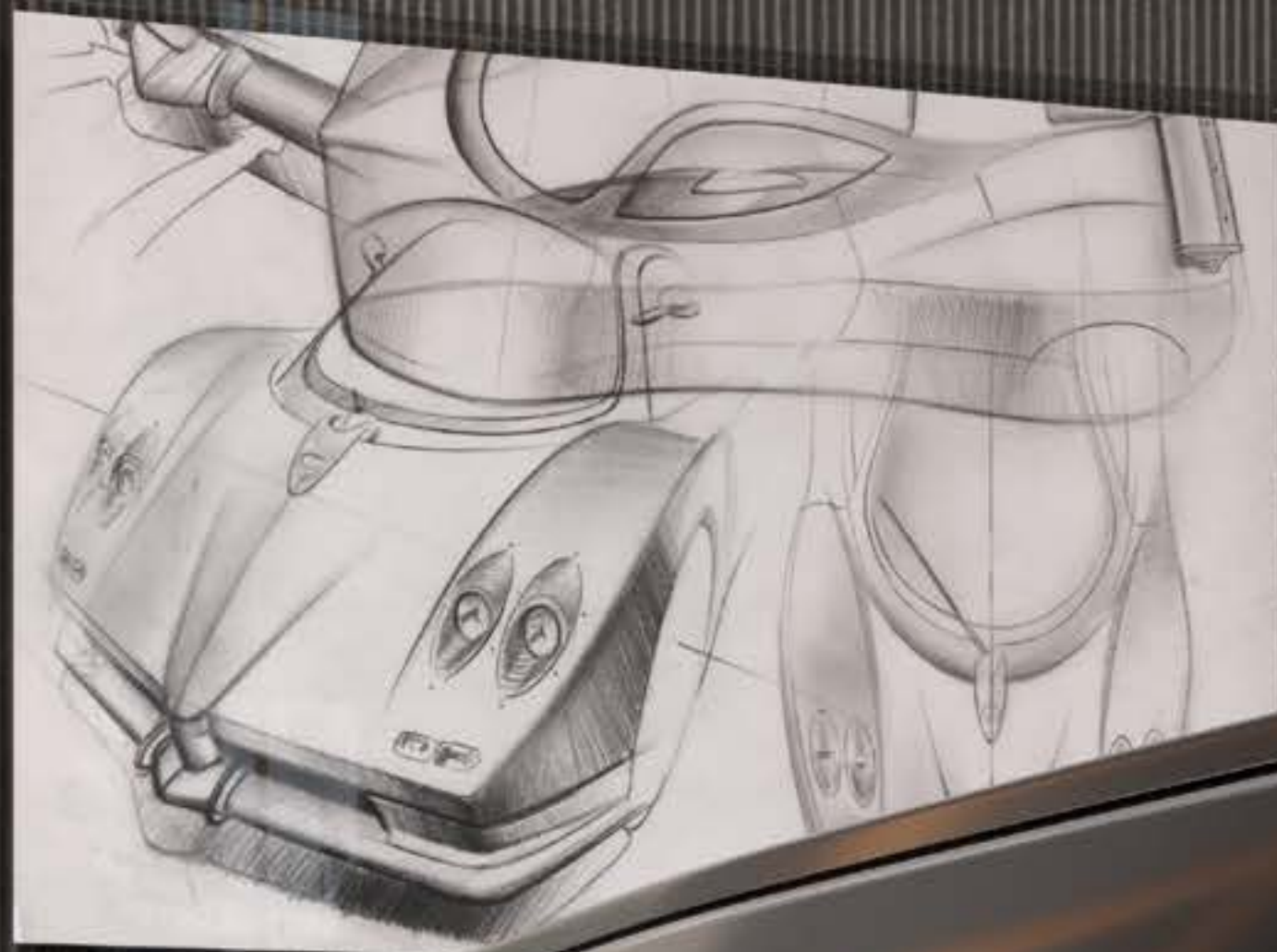
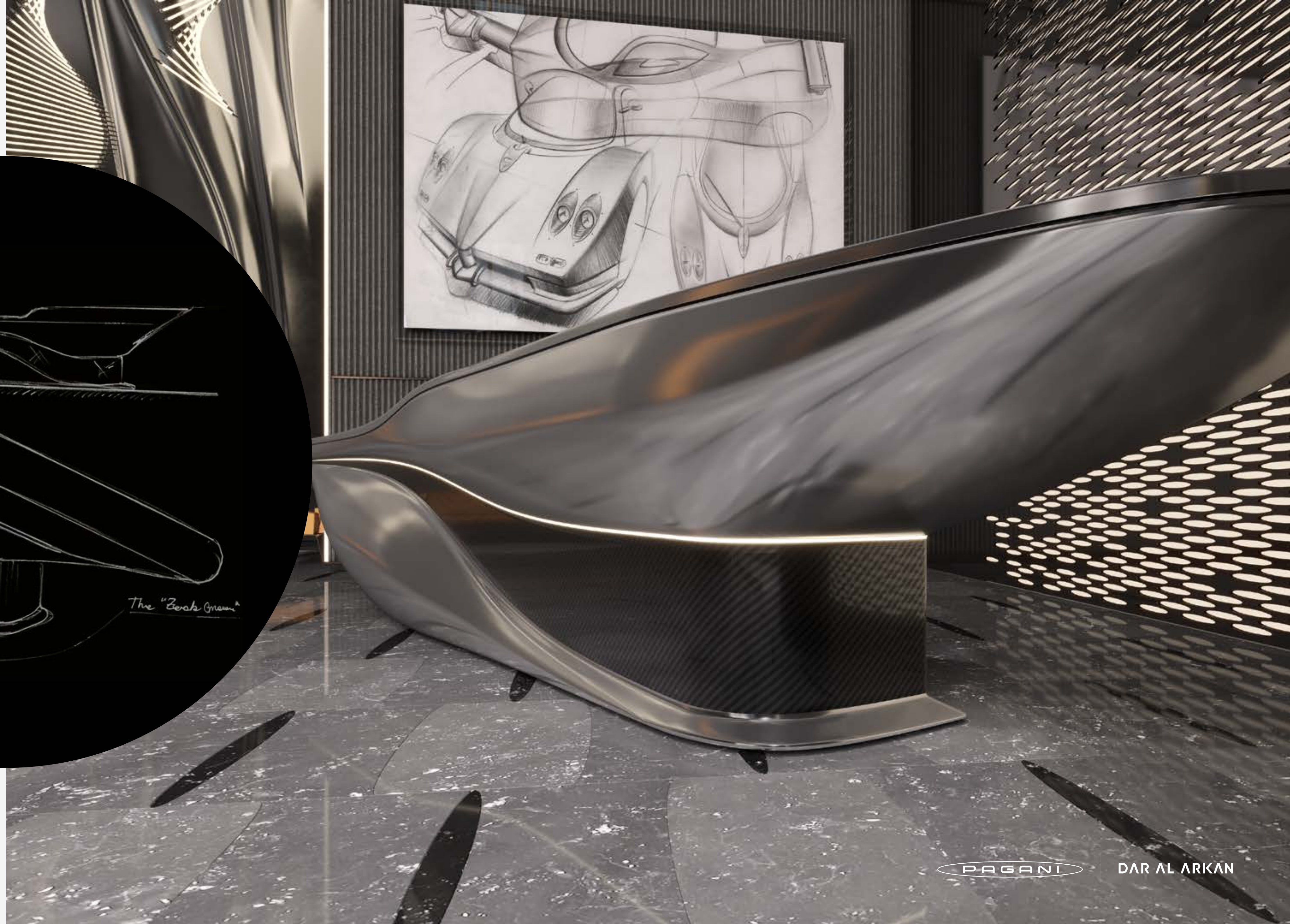

THE POOL

Dive INTO CALMNESS

Peace of mind is within reach when you are surrounded by harmony and balance.

Imagine a relaxing heaven where every shape is designed to please your senses: discover the pool area at the top of the tower, an urban jungle to refresh your ideas after a busy day.



CONCIERGERIE, *crafted*

Nothing is left behind when you live in a world of exclusivity. The residential services will meet any of your desires: our highly professional team will be available 24/7 to help you with housekeeping, arranging dinner plans or making the reservations you need.





Inspired TO WELL-BEING

Keep yourself fit and healthy, without having to leave your home. You can workout in a modern gym with the newest equipments and plenty of space to exercise, then give yourself a treat in the sauna and steam rooms for men and women.

A great way to start your day, or to end it.



PAGANI

DAR AL ARKAN





RESIDENCES SPECIFICATIONS

Foyer – Living Area – Dining Area

Marble flooring and skirting
Gypsum ceiling finished with paint
Paint with accent wallpaper
Wood paneling in selected areas

Kitchen

Marble flooring and skirting
Paint and quartz walls
Gypsum ceiling finished with paint
Silestone high quality quartz counter top
Lacquered paint cabinets
Fridge, Oven, Hob, Hood, Microwave,
Dishwasher, Washing Machine,
Beverage Cooler
Miele, Bosch Premium Line or Equivalent

Bedrooms

Semi Engineered wood flooring and skirting
Paint with accent wallpaper
Gypsum ceiling finished with paint
Built-in lacquered joinery

Bathrooms

Marble flooring and skirting
Marble / wallpaper walls
Moisture resistant gypsum ceiling finished
with paint
Marble counter top
Lacquered / Veneer joinery
Gessi, Newform or equivalent
sanitary fixtures
Kohler, Duravit, Geberit or equivalent
sanitaryware

All pictures, plans, layouts, information, data and details included in this brochure are indicative only and may change at any time up to the final 'as built' status in accordance with final designs of the project, regulatory approvals and planning permissions. All accessories and interior finishes such as wallpaper, chandeliers, furniture, electronics, white goods, curtains, hard and soft landscaping, pavements, features, gym, swimming pool(s) and other elements displayed in the brochure, or within the show apartment or between the plot boundary and the unit, are not part of the unit and are shown for illustrative purposes only.



FLOOR PLANS



2 BEDROOMS

– Type 7 –

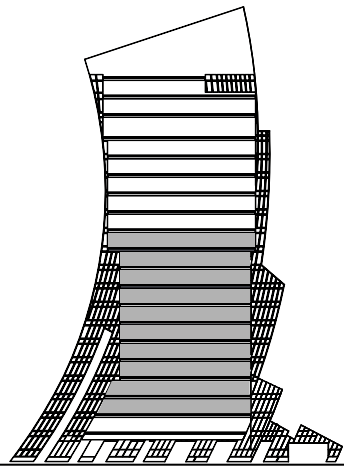

FLOORS
2 to 10

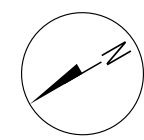
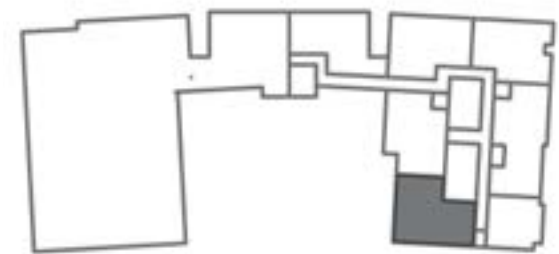

All pictures, plans, layouts, information, data and details included in this brochure are indicative only and may change at any time up to the final 'as built' status in accordance with final designs of the project, regulatory approvals and planning permissions. All accessories and interior finishes such as wallpaper, chandeliers, furniture, electronics, white goods, curtains, hard and soft landscaping, pavements, features, gym, swimming pool(s) and other elements displayed in the brochure, or within the show apartment or between the plot boundary and the unit, are not part of the unit and are shown for illustrative purposes only.



2 BEDROOMS – Type 7A –

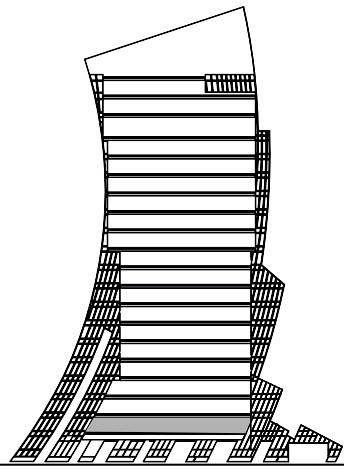

FLOOR
1

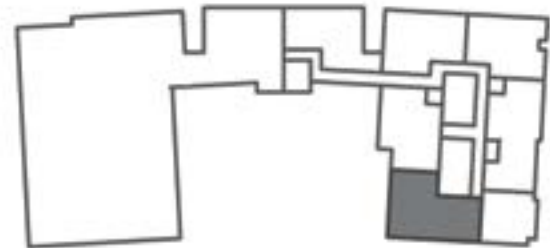

All pictures, plans, layouts, information, data and details included in this brochure are indicative only and may change at any time up to the final 'as built' status in accordance with final designs of the project, regulatory approvals and planning permissions. All accessories and interior finishes such as wallpaper, chandeliers, furniture, electronics, white goods, curtains, hard and soft landscaping, pavements, features, gym, swimming pool(s) and other elements displayed in the brochure, or within the show apartment or between the plot boundary and the unit, are not part of the unit and are shown for illustrative purposes only.

2 BEDROOMS

– Type 8 –

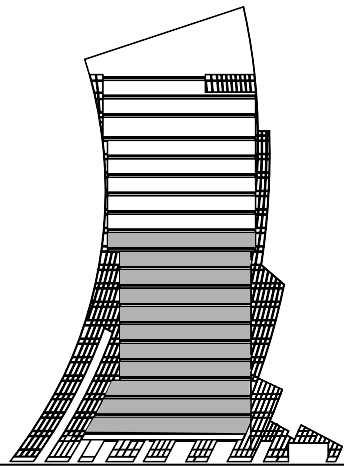

FLOORS
1 to 10

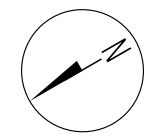
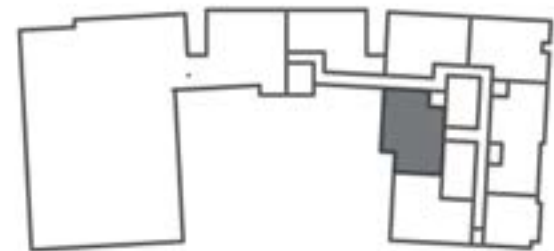

All pictures, plans, layouts, information, data and details included in this brochure are indicative only and may change at any time up to the final 'as built' status in accordance with final designs of the project, regulatory approvals and planning permissions. All accessories and interior finishes such as wallpaper, chandeliers, furniture, electronics, white goods, curtains, hard and soft landscaping, pavements, features, gym, swimming pool(s) and other elements displayed in the brochure, or within the show apartment or between the plot boundary and the unit, are not part of the unit and are shown for illustrative purposes only.

2 BEDROOMS

– Type 9 –

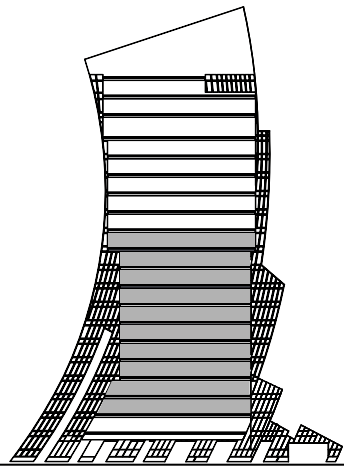

FLOORS
2 to 10

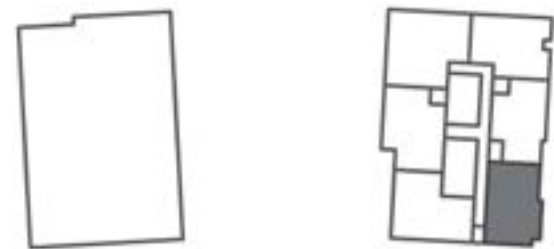

All pictures, plans, layouts, information, data and details included in this brochure are indicative only and may change at any time up to the final 'as built' status in accordance with final designs of the project, regulatory approvals and planning permissions. All accessories and interior finishes such as wallpaper, chandeliers, furniture, electronics, white goods, curtains, hard and soft landscaping, pavements, features, gym, swimming pool(s) and other elements displayed in the brochure, or within the show apartment or between the plot boundary and the unit, are not part of the unit and are shown for illustrative purposes only.

2 BEDROOMS

– Type 10 –

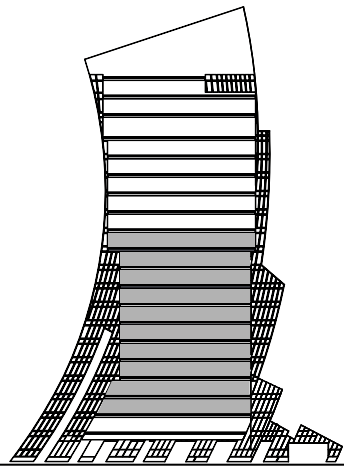

FLOORS
2 to 10

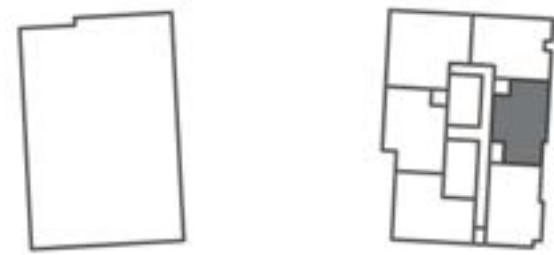

All pictures, plans, layouts, information, data and details included in this brochure are indicative only and may change at any time up to the final 'as built' status in accordance with final designs of the project, regulatory approvals and planning permissions. All accessories and interior finishes such as wallpaper, chandeliers, furniture, electronics, white goods, curtains, hard and soft landscaping, pavements, features, gym, swimming pool(s) and other elements displayed in the brochure, or within the show apartment or between the plot boundary and the unit, are not part of the unit and are shown for illustrative purposes only.

2 BEDROOMS – Type 11 –

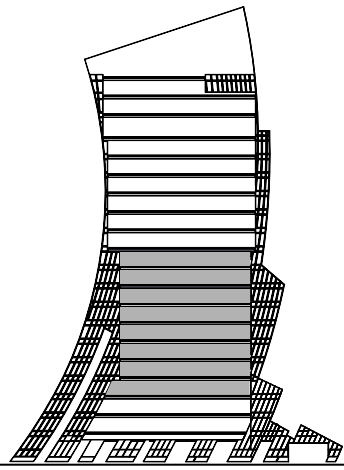

FLOORS
3 to 10

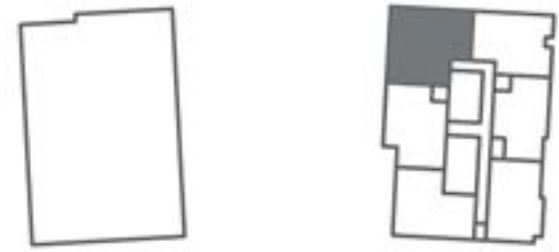

All pictures, plans, layouts, information, data and details included in this brochure are indicative only and may change at any time up to the final 'as built' status in accordance with final designs of the project, regulatory approvals and planning permissions. All accessories and interior finishes such as wallpaper, chandeliers, furniture, electronics, white goods, curtains, hard and soft landscaping, pavements, features, gym, swimming pool(s) and other elements displayed in the brochure, or within the show apartment or between the plot boundary and the unit, are not part of the unit and are shown for illustrative purposes only.

2 BEDROOMS

– Type 12 –

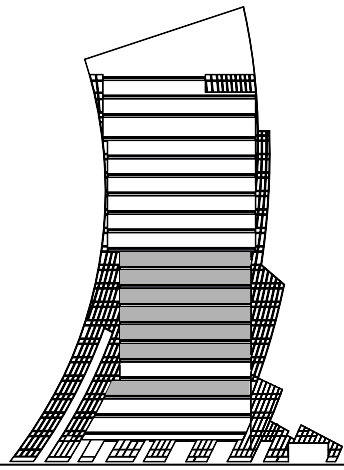

FLOORS
3, 5 to 10

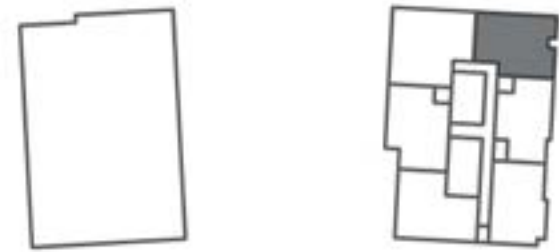

All pictures, plans, layouts, information, data and details included in this brochure are indicative only and may change at any time up to the final 'as built' status in accordance with final designs of the project, regulatory approvals and planning permissions. All accessories and interior finishes such as wallpaper, chandeliers, furniture, electronics, white goods, curtains, hard and soft landscaping, pavements, features, gym, swimming pool(s) and other elements displayed in the brochure, or within the show apartment or between the plot boundary and the unit, are not part of the unit and are shown for illustrative purposes only.

2 BEDROOMS

– Type 13 –

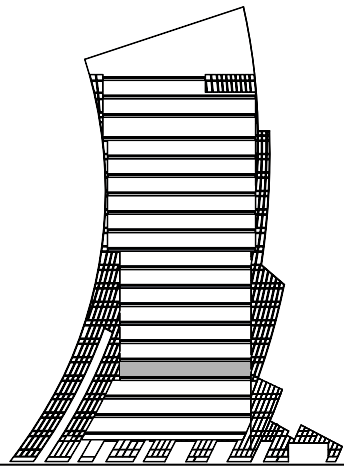

FLOOR
4

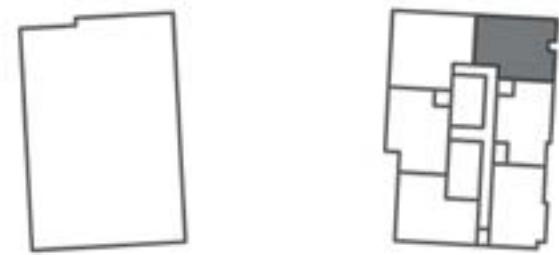

All pictures, plans, layouts, information, data and details included in this brochure are indicative only and may change at any time up to the final 'as built' status in accordance with final designs of the project, regulatory approvals and planning permissions. All accessories and interior finishes such as wallpaper, chandeliers, furniture, electronics, white goods, curtains, hard and soft landscaping, pavements, features, gym, swimming pool(s) and other elements displayed in the brochure, or within the show apartment or between the plot boundary and the unit, are not part of the unit and are shown for illustrative purposes only.

2 BEDROOMS

– Type 14 –

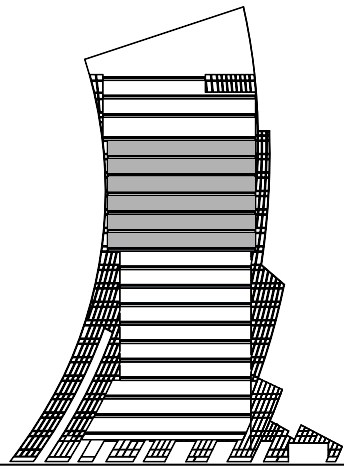

FLOORS
11 to 16

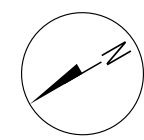
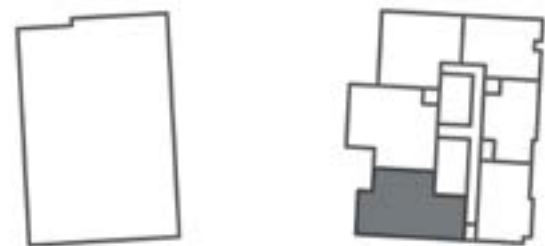

All pictures, plans, layouts, information, data and details included in this brochure are indicative only and may change at any time up to the final 'as built' status in accordance with final designs of the project, regulatory approvals and planning permissions. All accessories and interior finishes such as wallpaper, chandeliers, furniture, electronics, white goods, curtains, hard and soft landscaping, pavements, features, gym, swimming pool(s) and other elements displayed in the brochure, or within the show apartment or between the plot boundary and the unit, are not part of the unit and are shown for illustrative purposes only.

2 BEDROOMS

– Type 15 –

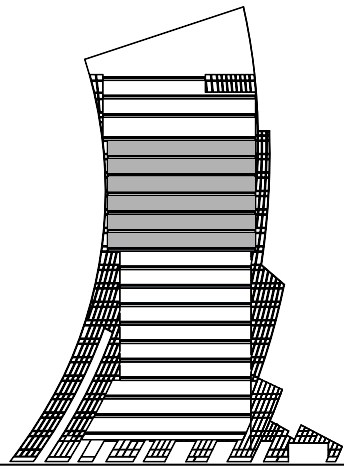

FLOORS
11 to 16

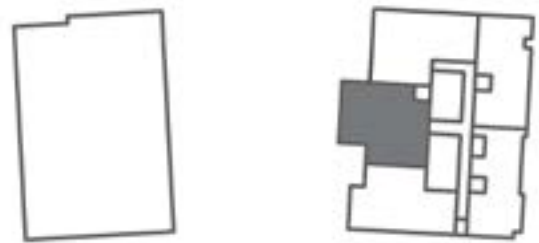

All pictures, plans, layouts, information, data and details included in this brochure are indicative only and may change at any time up to the final 'as built' status in accordance with final designs of the project, regulatory approvals and planning permissions. All accessories and interior finishes such as wallpaper, chandeliers, furniture, electronics, white goods, curtains, hard and soft landscaping, pavements, features, gym, swimming pool(s) and other elements displayed in the brochure, or within the show apartment or between the plot boundary and the unit, are not part of the unit and are shown for illustrative purposes only.



2 BEDROOMS
- Type 16 -

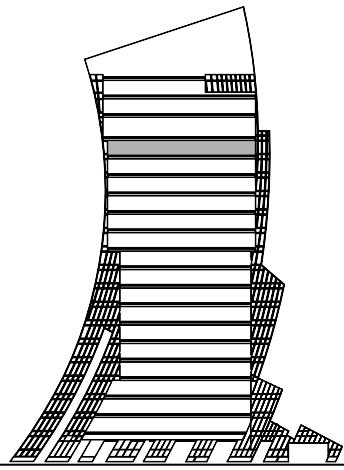

FLOOR
16

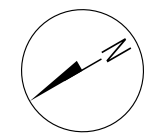
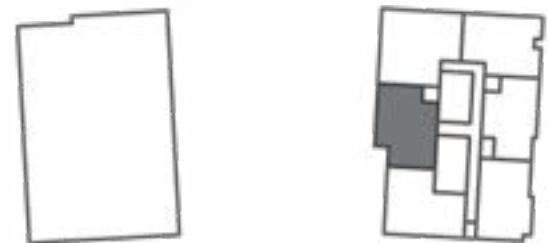

All pictures, plans, layouts, information, data and details included in this brochure are indicative only and may change at any time up to the final 'as built' status in accordance with final designs of the project, regulatory approvals and planning permissions. All accessories and interior finishes such as wallpaper, chandeliers, furniture, electronics, white goods, curtains, hard and soft landscaping, pavements, features, gym, swimming pool(s) and other elements displayed in the brochure, or within the show apartment or between the plot boundary and the unit, are not part of the unit and are shown for illustrative purposes only.

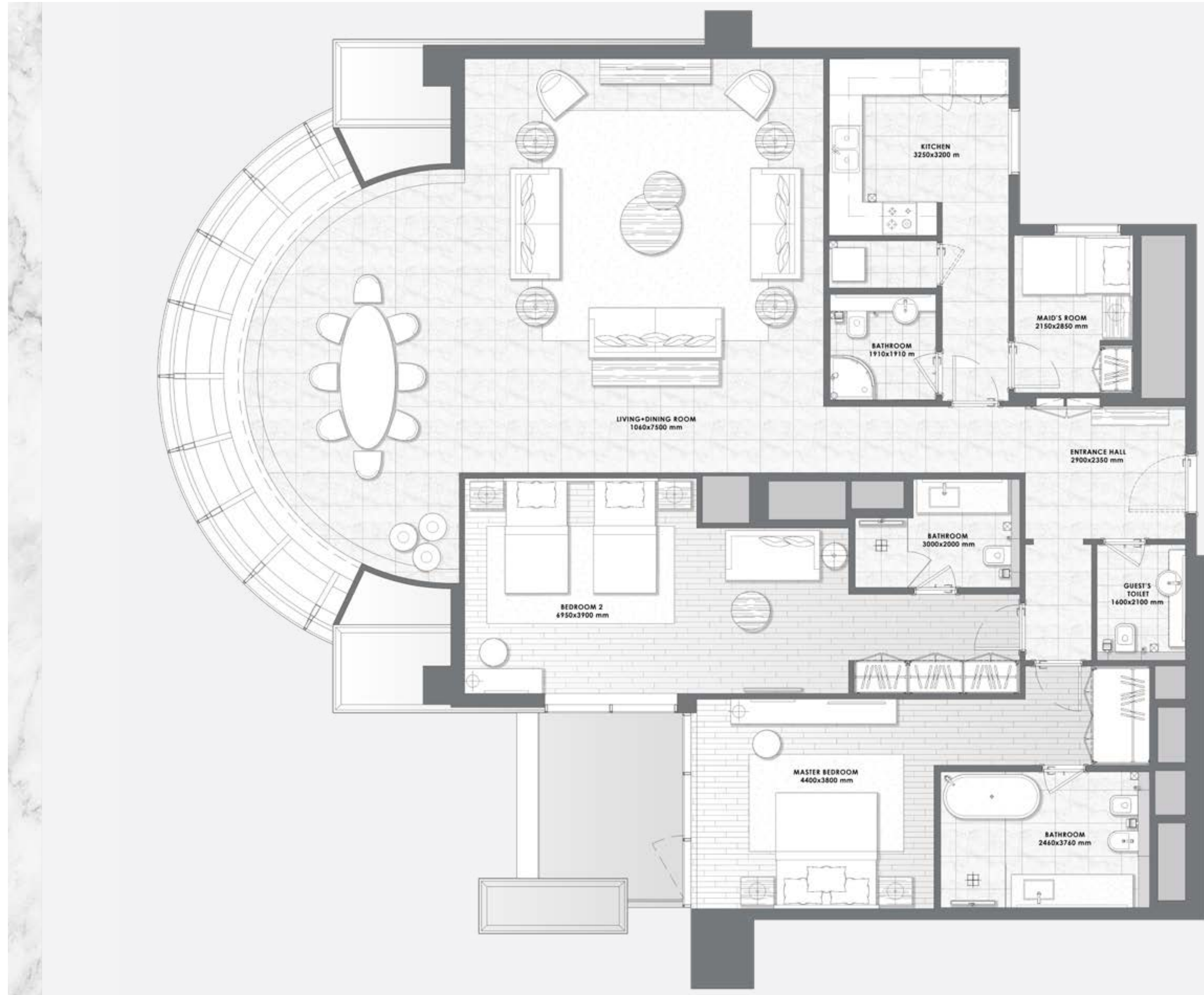

3 BEDROOMS
 – Type 1 –

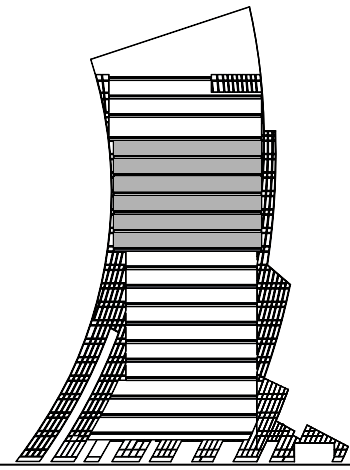

FLOORS
 11 to 16

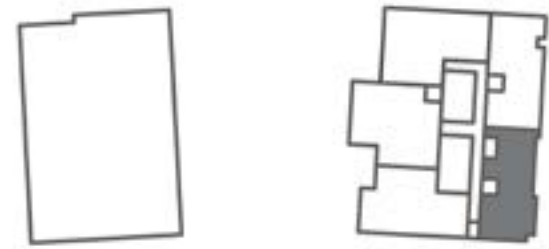

All pictures, plans, layouts, information, data and details included in this brochure are indicative only and may change at any time up to the final 'as built' status in accordance with final designs of the project, regulatory approvals and planning permissions. All accessories and interior finishes such as wallpaper, chandeliers, furniture, electronics, white goods, curtains, hard and soft landscaping, pavements, features, gym, swimming pool(s) and other elements displayed in the brochure, or within the show apartment or between the plot boundary and the unit, are not part of the unit and are shown for illustrative purposes only.



3 BEDROOMS

- Type 2 -

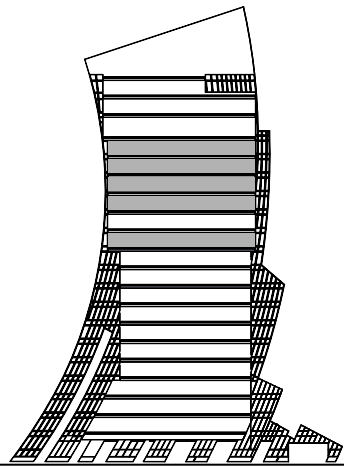

FLOORS
11, 13 to 16

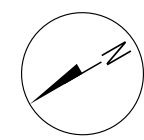
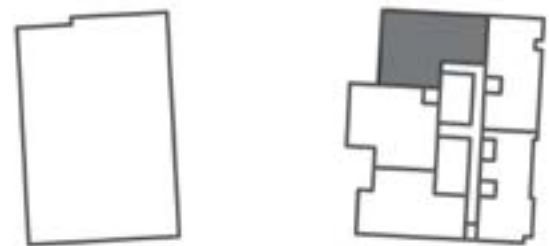

All pictures, plans, layouts, information, data and details included in this brochure are indicative only and may change at any time up to the final 'as built' status in accordance with final designs of the project, regulatory approvals and planning permissions. All accessories and interior finishes such as wallpaper, chandeliers, furniture, electronics, white goods, curtains, hard and soft landscaping, pavements, features, gym, swimming pool(s) and other elements displayed in the brochure, or within the show apartment or between the plot boundary and the unit, are not part of the unit and are shown for illustrative purposes only.

3 BEDROOMS – Type 2A –

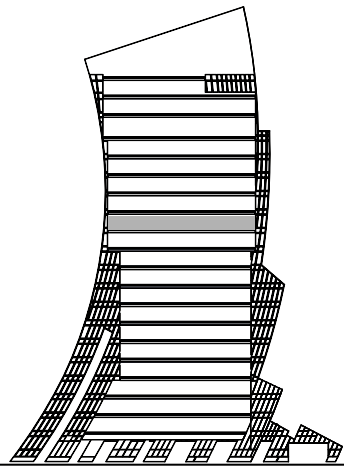

FLOOR
12

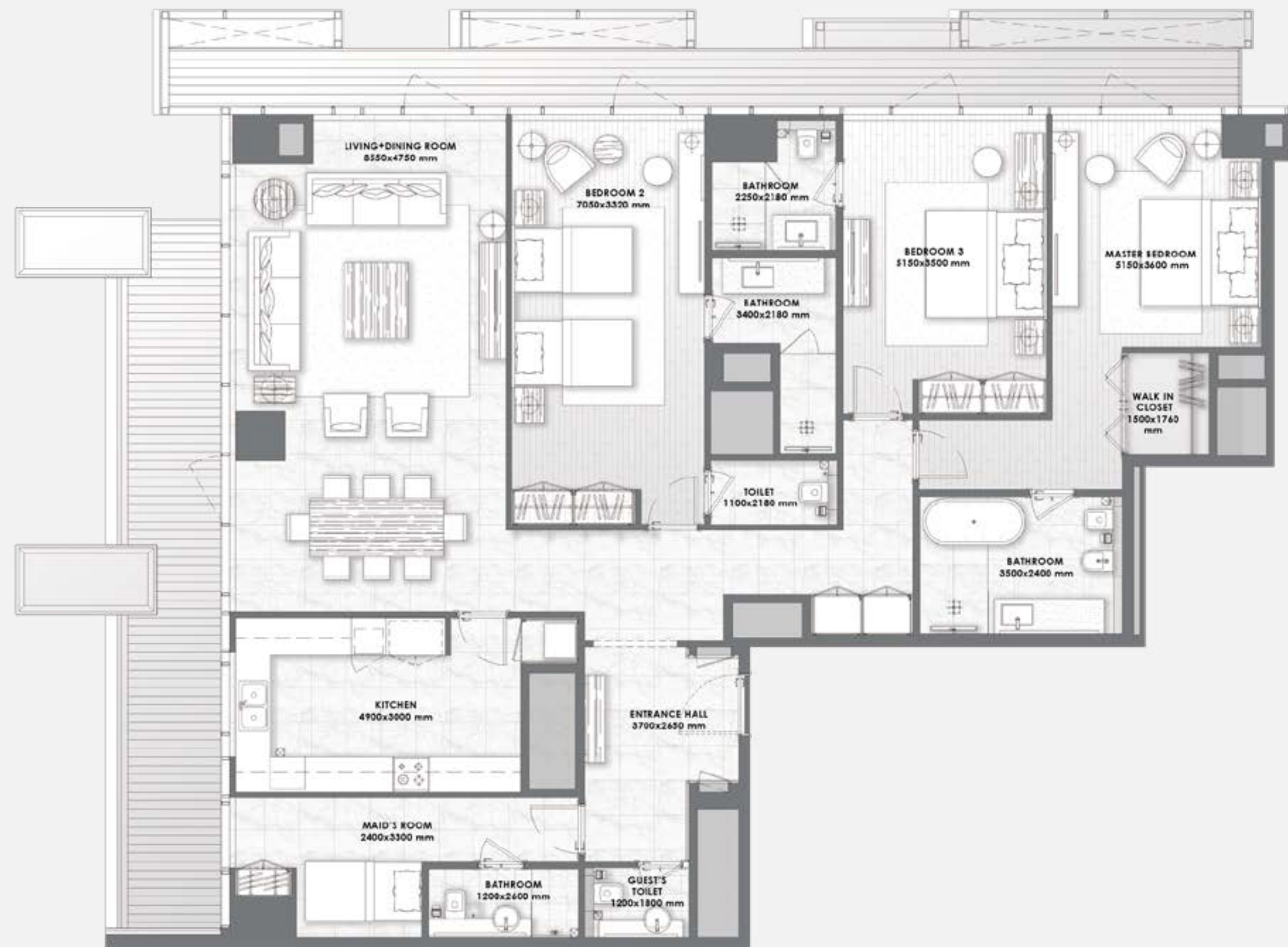
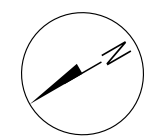
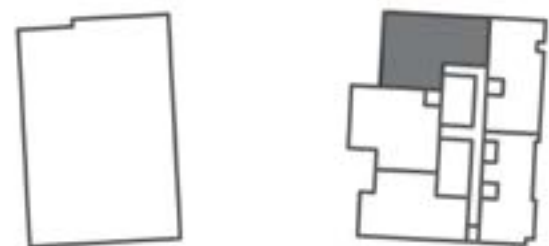

All pictures, plans, layouts, information, data and details included in this brochure are indicative only and may change at any time up to the final 'as built' status in accordance with final designs of the project, regulatory approvals and planning permissions. All accessories and interior finishes such as wallpaper, chandeliers, furniture, electronics, white goods, curtains, hard and soft landscaping, pavements, features, gym, swimming pool(s) and other elements displayed in the brochure, or within the show apartment or between the plot boundary and the unit, are not part of the unit and are shown for illustrative purposes only.

3 BEDROOMS – Type 3 –

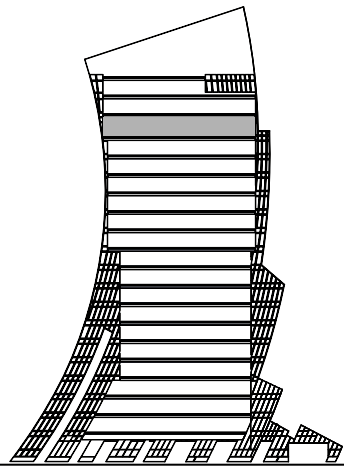

FLOOR
17

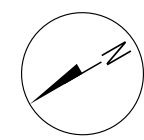
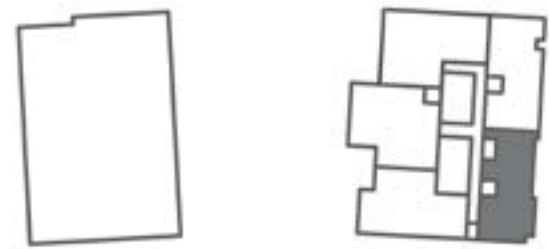

All pictures, plans, layouts, information, data and details included in this brochure are indicative only and may change at any time up to the final 'as built' status in accordance with final designs of the project, regulatory approvals and planning permissions. All accessories and interior finishes such as wallpaper, chandeliers, furniture, electronics, white goods, curtains, hard and soft landscaping, pavements, features, gym, swimming pool(s) and other elements displayed in the brochure, or within the show apartment or between the plot boundary and the unit, are not part of the unit and are shown for illustrative purposes only.



3 BEDROOMS
 DUPLEX
 – Type 2 –

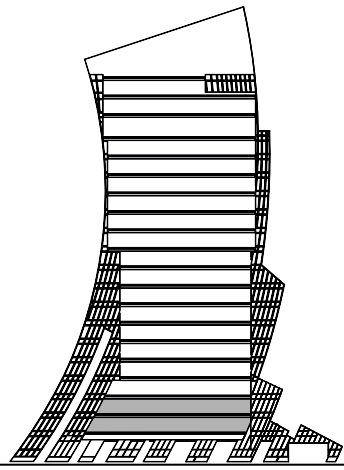

FLOORS
 1 & 2

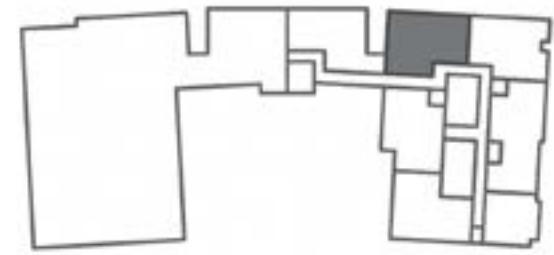

LOWER LEVEL



UPPERLEVEL

All pictures, plans, layouts, information, data and details included in this brochure are indicative only and may change at any time up to the final 'as built' status in accordance with final designs of the project, regulatory approvals and planning permissions. All accessories and interior finishes such as wallpaper, chandeliers, furniture, electronics, white goods, curtains, hard and soft landscaping, pavements, features, gym, swimming pool(s) and other elements displayed in the brochure, or within the show apartment or between the plot boundary and the unit, are not part of the unit and are shown for illustrative purposes only.

4 BEDROOMS

– Type 1 –

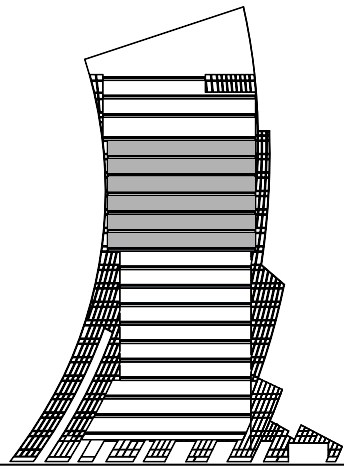

FLOORS
11 to 16

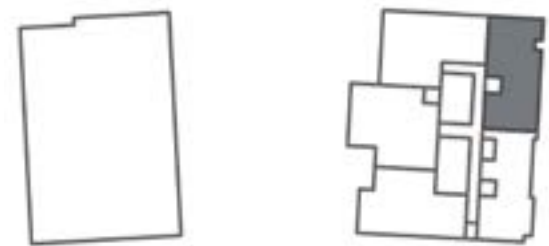

All pictures, plans, layouts, information, data and details included in this brochure are indicative only and may change at any time up to the final 'as built' status in accordance with final designs of the project, regulatory approvals and planning permissions. All accessories and interior finishes such as wallpaper, chandeliers, furniture, electronics, white goods, curtains, hard and soft landscaping, pavements, features, gym, swimming pool(s) and other elements displayed in the brochure, or within the show apartment or between the plot boundary and the unit, are not part of the unit and are shown for illustrative purposes only.



4 BEDROOMS – Type 1A –

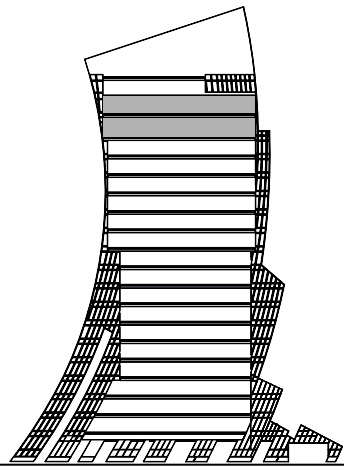

FLOORS
17 to 18

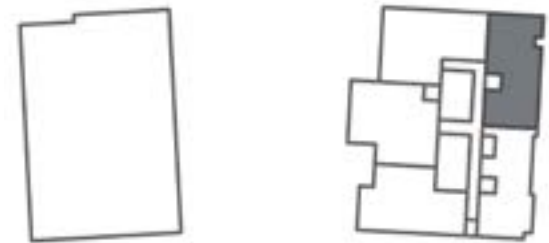

All pictures, plans, layouts, information, data and details included in this brochure are indicative only and may change at any time up to the final 'as built' status in accordance with final designs of the project, regulatory approvals and planning permissions. All accessories and interior finishes such as wallpaper, chandeliers, furniture, electronics, white goods, curtains, hard and soft landscaping, pavements, features, gym, swimming pool(s) and other elements displayed in the brochure, or within the show apartment or between the plot boundary and the unit, are not part of the unit and are shown for illustrative purposes only.



4 BEDROOMS – Type 2 –

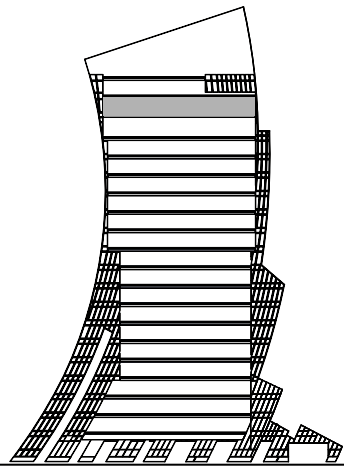

FLOOR
18

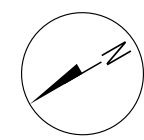
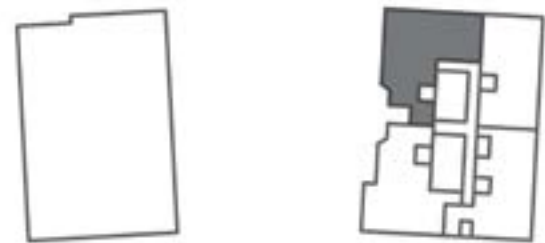

All pictures, plans, layouts, information, data and details included in this brochure are indicative only and may change at any time up to the final 'as built' status in accordance with final designs of the project, regulatory approvals and planning permissions. All accessories and interior finishes such as wallpaper, chandeliers, furniture, electronics, white goods, curtains, hard and soft landscaping, pavements, features, gym, swimming pool(s) and other elements displayed in the brochure, or within the show apartment or between the plot boundary and the unit, are not part of the unit and are shown for illustrative purposes only.



4 BEDROOMS

- Type 3 -

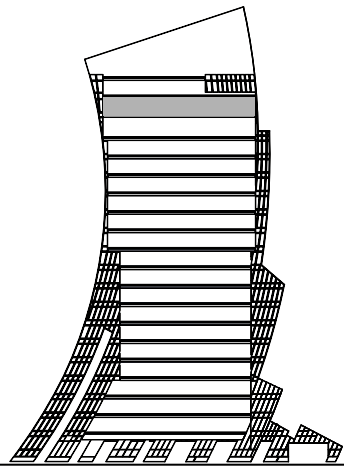

FLOOR
18

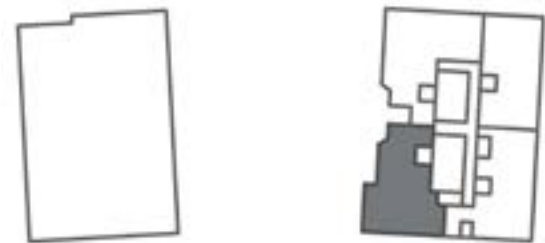

All pictures, plans, layouts, information, data and details included in this brochure are indicative only and may change at any time up to the final 'as built' status in accordance with final designs of the project, regulatory approvals and planning permissions. All accessories and interior finishes such as wallpaper, chandeliers, furniture, electronics, white goods, curtains, hard and soft landscaping, pavements, features, gym, swimming pool(s) and other elements displayed in the brochure, or within the show apartment or between the plot boundary and the unit, are not part of the unit and are shown for illustrative purposes only.



4 BEDROOMS DUPLEX – Type 2 –

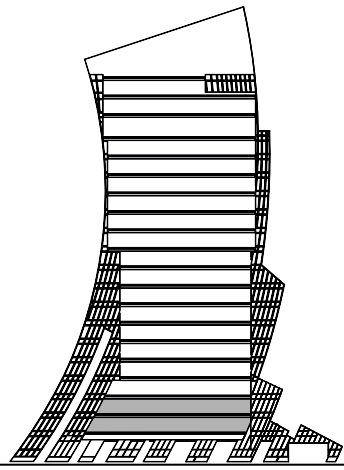

FLOORS
1 & 2

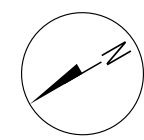

LOWER LEVEL



UPPERLEVEL

All pictures, plans, layouts, information, data and details included in this brochure are indicative only and may change at any time up to the final 'as built' status in accordance with final designs of the project, regulatory approvals and planning permissions. All accessories and interior finishes such as wallpaper, chandeliers, furniture, electronics, white goods, curtains, hard and soft landscaping, pavements, features, gym, swimming pool(s) and other elements displayed in the brochure, or within the show apartment or between the plot boundary and the unit, are not part of the unit and are shown for illustrative purposes only.

4 BEDROOMS
 – Type 4 –

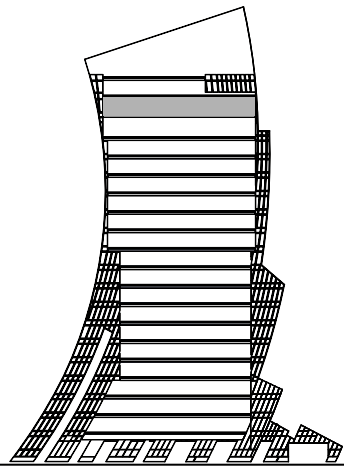

FLOOR
 18

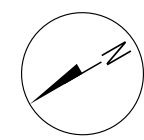
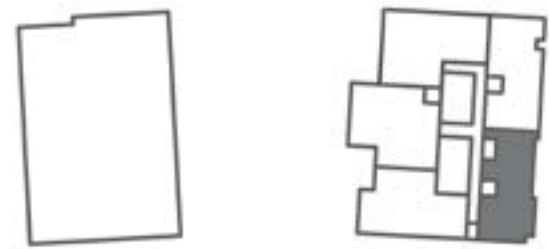

All pictures, plans, layouts, information, data and details included in this brochure are indicative only and may change at any time up to the final 'as built' status in accordance with final designs of the project, regulatory approvals and planning permissions. All accessories and interior finishes such as wallpaper, chandeliers, furniture, electronics, white goods, curtains, hard and soft landscaping, pavements, features, gym, swimming pool(s) and other elements displayed in the brochure, or within the show apartment or between the plot boundary and the unit, are not part of the unit and are shown for illustrative purposes only.



DAR AL ARKAN

BUILDING YOUR TRUST



Imagine a partner that anticipates your needs, understands your aspirations, and celebrates your successes. A partner that cuts through all the red tape and instead offers you on a golden platter the ideal home planned by world-class architects, built with world-class materials, designed by icons of fashion and managed & maintained by the top experts. And this commitment to delivering the highest quality projects hasn't wavered for the past 27 years. **This is Dar Al Arkan.**

—
15,000

residential units delivered

—
500,000 SQM

of commercial space

—
OPERATING ON
3 CONTINENTS

—
SAR 31 BILLION

in assets (month 2021)

—
SAR 11 BILLION

in capital (month 2021)

—
SAUDI STOCK
EXCHANGE

listed

HEAD OFFICE

Riyadh, KSA
12622 Makkah Road,
Al Wizarat, Beside Riyadh
Marriott Hotel, Riyadh

800 123 3333
info@alarkan.com

SALES CENTRES

Riyadh, KSA
Al Qasr Mall, As Suwaidi
Al Am, As Suwaidi, 12791,
Riyadh

Riyadh, KSA
Shams Ar Riyadh,
13913 Salbukh Road,
Riyadh

Jeddah, KSA
Office 83, Al Mukhmal
Tower, Al-Khalidiya,
23422, Prince Saud Al
Faisal Road, Jeddah

Medina, KSA
Prince Sultan Road – Al Hijra,
Al Madinah Al Munawarah,
Medina

Dubai, UAE
Conrad Dubai,
Sheikh Zayed Road,
Opposite
World Trade Centre,
PO Box 2523, Dubai
+971 800 40404

Sarajevo, BiH
Ul. Fra Andela,
Zvizdovica Br. 1,
D-mezanin,
71 000 Sarajevo, BiH

Beijing, China
303-309, North Tower,
Beijing Kerry Centre,
No.1 Guanghai Road,
Chaoyang District
Beijing
+86 132 5888 6222

DAR AL ARKAN

daralarkan.com